

DD-1008-HL

Call 800-321-7800 or visit us online at www.nookindustries.com to configure and order your DD-1008-HL today!

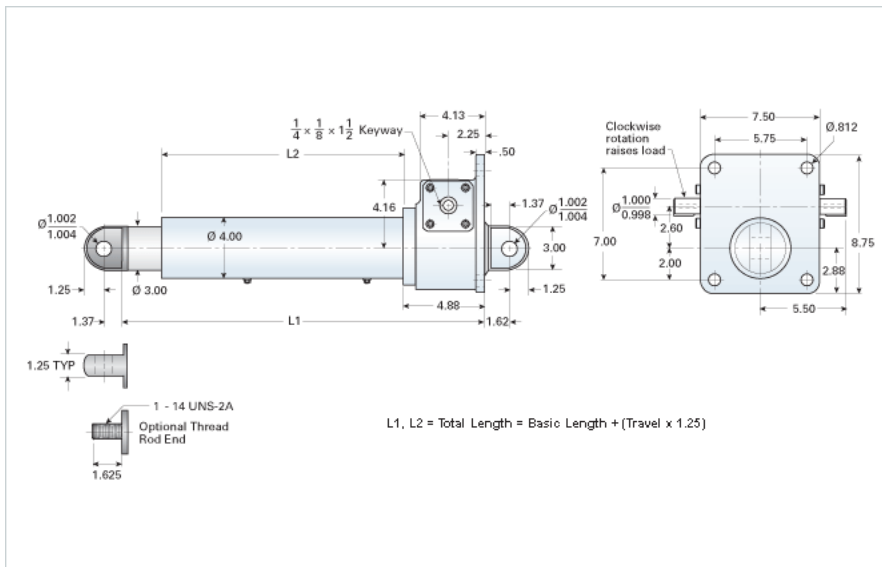

Details

Gear Ratio	8:1
Max Capacity [lb]	20000
Input Turns Per Inch Of Travel	8
Torque To Raise 1 lb. [in-lb]	0.0319
Ball Screw	1500-1000 SRT RA
Screw Lead [in]	1.000
Root Diameter [in]	1.000
Max HP [hp]	5

Weight

Basic Weight [lb]	80
Per Inch of Travel [lb]	1.92

Tube Dimensions

L1 Basic Length [in]	15.25
L2 Basic Length [in]	8.88

NEMA 42 Dimensions

L3 [in]	-
E [in]	-
F [in]	-

NEMA 48 Dimensions

L3 [in]	-
E [in]	-
F [in]	-

NEMA 56C Dimensions

L3 [in]	8.25
E [in]	4.38
F [in]	6.75

NEMA 182TC Dimensions

L3 [in]	9.00
E [in]	9.25

NEMA 182TC/18TCc Dimensions

F [in]	4.38
--------	------

NEMA 184TC Dimensions

L3 [in]	-
E [in]	-
F [in]	-

NEMA 213TC Dimensions

L3 [in]	-
E [in]	-
F [in]	-