

## DLK 200 Extended Carriage 6 Split Rollers

Call 800-321-7800 or visit us online at [www.nookindustries.com](http://www.nookindustries.com) to configure and order your DLK 200 Extended Carriage 6 Split Rollers today!

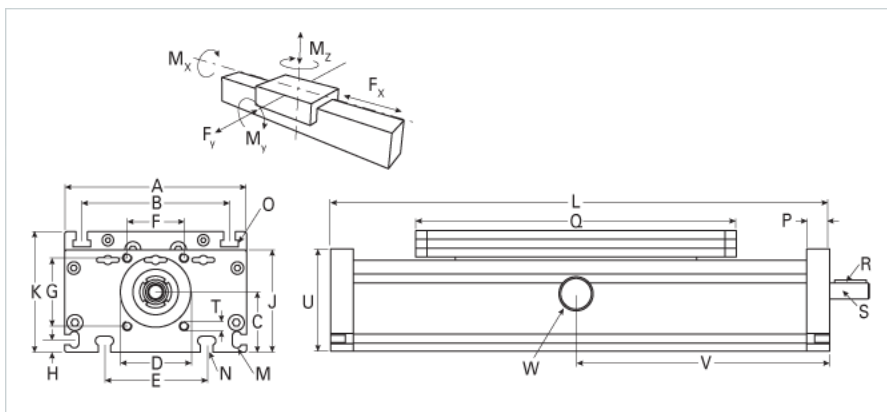

Details	
Size	200
Screw Options	32x5/32x10/32x20/32x32
Screw Type	Ball Screw
Dimensions	
Basic Length L [mm]	460
A [mm]	200
B [mm]	160
C [mm]	66
D [mm]	68
E [mm]	140
F [mm]	60
H [mm]	15
J [mm]	110
K [mm]	129
M	M 8
N	M 10
O	M 10
P [mm]	20
Q [mm]	410
Shaft R Key [mm]	6x6x40
Shaft S Diameter x Length [mm]	22 h6 x 45
T	M 8
Forces and Torques	
No Load Torque-Dynamic	1.1
Fx dynamic [N]	8000
Fy dynamic [N]	3100
Fz dynamic [N]	4400
Mx dynamic [Nm]	510
My dynamic [Nm]	480
Mz dynamic [Nm]	275
Fx static [N]	10000
Fy static [N]	4400
Fz static [N]	4900
Mx static [Nm]	600
My static [Nm]	560
Mz static [Nm]	310
Geometrical moments of inertia of aluminum profile	
Elastic modulus [N/mm <sup>2</sup> ]	70000
Ix [mm <sup>4</sup> ]	6380000
Iy [mm <sup>4</sup> ]	33500000
Weight	
Additional Weight per 100 mm [kg]	2.82
Basic Weight [kg]	19.6