

RAD-20088-HD/30XX

Call 800-321-7800 or visit us online at www.nookindustries.com to configure and order your RAD-20088-HD/30XX today!

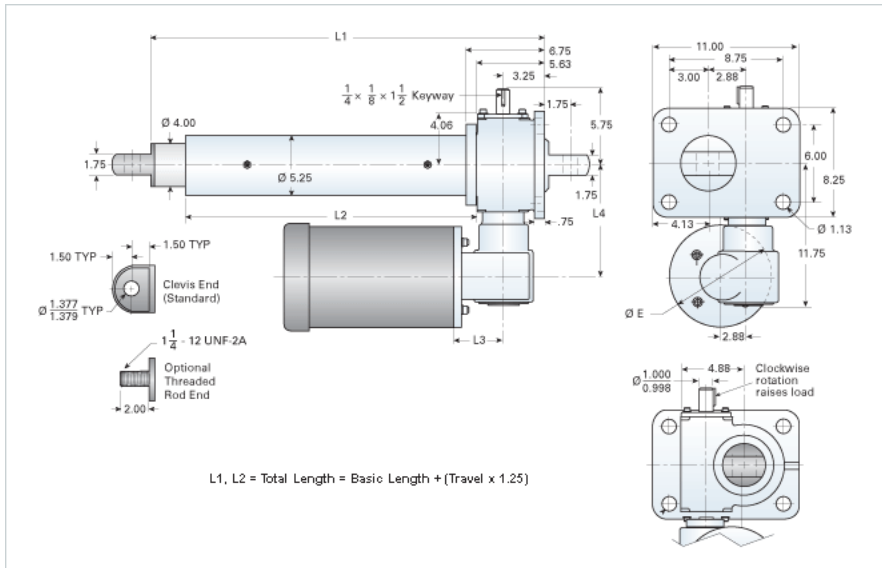

Performance Specifications

Travel Rate [in/min]	13.5
Dynamic Capacity [lb]	35000
Rated Life [in]	230000
Motor Horse Power	3
Maximum Rod Reaction Torque [in-lb]	3098
Std. Brake Torque [ft-lb]	15
Approximate Stopping Distance No Load [in]	0.03
Approximate Stopping Distance Full Load [in]	0.03

Details

Gear Ratio Primary Reduction	8:1
Gear Ratio Secondary Reduction	8:1
Input Turns Per Inch Of Travel	128
Torque To Raise 1 lb. [in-lb]	0.0031
Max Capacity [lb]	40000
Max HP [hp]	3

Weight

Basic Weight [lb]	202
Per Inch of Travel [lb]	3.31

Tube Dimensions

L1 Basic Length [in]	21.13
L2 Basic Length [in]	12.63

NEMA 56C Dimensions

L3 [in]	-
L4 [in]	-
E [in]	-

NEMA 180TC Dimensions

L3 [in]	6.12
L4 [in]	9.00
F [in]	9.12