

RAD-10082-A2/10XX

Call 800-321-7800 or visit us online at www.nookindustries.com to configure and order your RAD-10082-A2/10XX today!

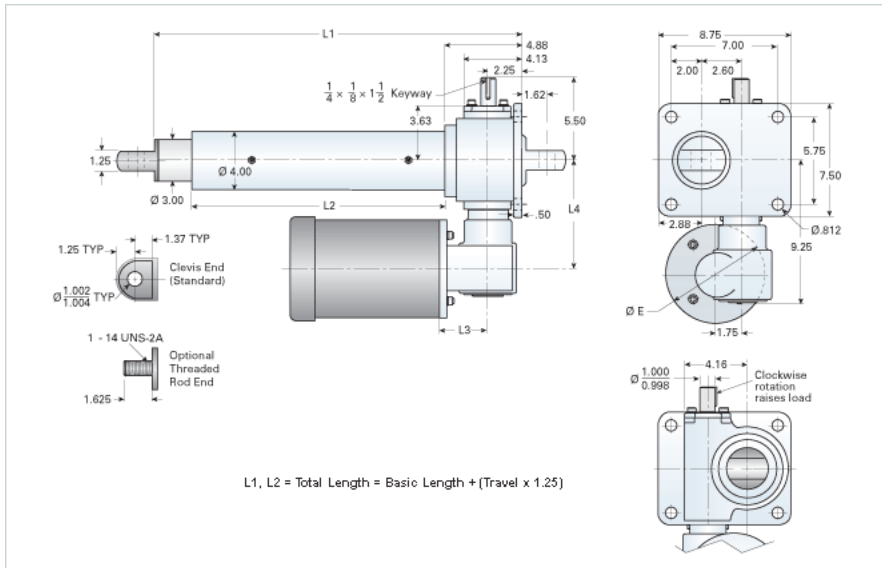

Performance Specifications

Travel Rate [in/min]	9
Dynamic Capacity [lb]	6275
Motor Horse Power	1
Maximum Rod Reaction Torque [in-lb]	1249
Std. Brake Torque [ft-lb]	6
Approximate Stopping Distance No Load [in]	0.07

Details

Gear Ratio Primary Reduction	8:1
Gear Ratio Secondary Reduction	12:1
Input Turns per Inch of Travel	192
Torque to Raise 1 lb. [in-lb]	0.0058
Max Capacity [lb]	20000
Max HP [hp]	1

Weight

Basic Weight [lb]	89
Per Inch of Travel [lb]	2.50

Tube Dimensions

L_1 Basic Length [in]	12.88
L_2 Basic Length [in]	6.50

NEMA 56C Dimensions

L_3 [in]	3.69
L_4 [in]	5.63
E [in]	6.69

NEMA 180TC Dimensions

L_3 [in]	-
L_4 [in]	-
F [in]	-